

# aumüller

## Installation and Commissioning Instructions



RADIO VENTILATION CONTROL **FLS 24V** CE

01	<p><b>Preliminary remark</b>  <b>Description</b>                  Scope of supply, Commissioning procedure,                  Options for connection and control, Overview of available automatic functions</p>	3 - 4
02	<p><b>Operation</b>                  Key functions and display symbols of the meteorological data display                  Display of lightness and wind speed  <b>Manual operation</b>                  Move window manually, Switch between manual and automatic                  Central control, Settings (default setting, automatic)</p>	5 - 6
03	<p><b>Setting of automatic</b>                  A. Indoor temperature for opening                  B. Outdoor temperature block                  C. Wind alarm (Table for wind speeds)                  D. Rain alarm                  E. Storage of automatic settings</p>	7 - 9
04	<p><b>Basic settings</b>                  1. Radio connection to the weather station                  2. Rotational direction of the motor                  3. Operating direction                  4. Operating command in case of wind or rain alarm                  5. Sending of meteorological and automatic data                  6. Opening position                  7. Saving of basic settings</p>	9 - 13
05	<p><b>Safety instructions</b>                  Automatic functions and alarm functions                  Installation and Commissioning  <b>Installation of weather station and connection of drive mechanism</b>                  Position, Attaching the mount, Preparation of the weather station,                  Connection of voltage supply and drive mechanism, Mounting of the weather station,                  Details for the installation of the weather station</p>	14 - 17
06	<p><b>Installation of operating unit</b>  <b>Installation of the radio system</b>                  Commissioning  <b>Sensor testing</b>                  Sun sensor testing, Wind sensor testing, Rain sensor testing, Temperature sensor testing</p>	18 - 19
07	<p><b>Service</b>  <b>Service and maintenance</b>                  Weather station, Operating unit, Insert batteries (operating unit), Error messages, Query service data  <b>Factory settings</b></p>	19 - 20
08	<p><b>Technical data</b>                  Operating unit, Weather station, View of rear side and drill hole plan for the weather station                  View of rear side and drill hole plan for the operating unit, Personal setting data of the automatic</p>	21 - 24

## ABBREVIATIONS

## Index of abbreviations

These abbreviations are used consistently throughout these assembly & operating instructions. Unless stated differently, all dimensions indicated in this document are in mm. General tolerances in accordance with DIN ISO 2768-m.

kLux	Kilolux (= 1000 Lux), Einheit der Lichtstärke
m/s	Meter pro Sekunde, Einheit der Windstärke
<b>A</b>	Automatic-Modus
CLR	Clear, Löschen
CLS	Close, Schließen
CON	Continue, Weiter
do	Down, Auf
ER	Error, Fehler
LEA	Learn, Lernen
OFF	AUS, abgeschaltet
ON	EIN, eingeschaltet
OPN	Open, Öffnen
PAN	Panel
R	Text
SAV	Save, Sichern der vorgenommenen Einstellungen
SOL	Text
UP	Up, Ab

 **WARNING**

Once the assembly and commissioning has been completed, the installer of a machine „power-operated window and door“ shall hand these instructions over to the end-user. The end-user shall store these instructions in a safe place for further reference and use, if required.

## WARNING AND SAFETY SYMBOLS:

The symbols used in the instructions shall be strictly observed and have the following meaning:

**Caution / Warning**

Danger due to electric current.

**Attention / Warning**

Risk of damage to / destruction of drives and / or windows.

**WARNING**

Failure to comply with the warning notes can result in irreversible injuries or death.

**NOTE**

Failure to comply with the warning notes can lead to damage to property.



Connection only executed by specialist personnel in accordance with the national guidelines.



Only connect when disconnected from the mains power supply!  
Switch off power supply and secure against reconnection!



Warranty claims require proper and professional assembly, installation and maintenance in accordance with national regulations and manufacturer's instructions as to SHEV Control Unit. Always disconnect the system from power supply and back-up battery voltage prior to any installation or modification work on the control unit.



Strictly observe the information given in the SHEV Control Unit description, when mounting the **Radio Ventilation Control**. Details can be found on our website [www.aumueller-gmbh.de](http://www.aumueller-gmbh.de)  
Keep this instruction over the lifetime of the product.

**DESCRIPTION**

**The Radio Ventilation Control FLS 24V**

in conjunction with a separate SHEV or Ventilation Control Unit, can automatically control the opening / closing of power windows. The automatic control unit can be individually adapted to your circumstances via the radio control panel and also enables convenient operation of the windows by hand.

**Scope of supply**

The Radio Ventilation Control **FLS 24V** The Arexa window control system consists of weather station and operating unit. Batteries for the operation of the operating unit are included in the scope of delivery (2 pcs.)

**Commissioning procedure**



Installation, inspection, commissioning and troubleshooting of the control system must only be carried out by a competent electrician.

Proceed as follows when commissioning the Radio Ventilation Control **FLS 24V**:

1. Installation and connection (see chapter „Installation and commissioning“)
2. Basic setting (see chapter „Basic settings“)
3. Setting of the automatic (see chapter „Setting of automatic“)

**Options for connection and control**

Connection devices (e.g. SHEV - Control Unit, Control devices, module) with window drives may be connected to the Radio Ventilation Control **FLS 24V**. The connected drives can be manually operated via the radio control panel.

It can be a radio control panel and additionally another wireless remote control (optional) operated with the weather station (maximum of two radio subscribers at the weather station).

The following **environmental parameters** are measured and displayed:

- Outdoor and indoor temperatur
- Lightness
- Wind speed
- Precipitation

**Overview of available automatic functions**

- Open when a selectable indoor temperature is reached
- Close and keep closed below a selectable outdoor temperature (outdoor temperature block)
- Open until a programmable position is reached
- Close when a selectable wind speed is reached (wind alarm, function may be deactivated)
- Close in case of rain (rain alarm, function may be deactivated)

The window is closed in automatic mode as soon as the value of a set indoor temperature falls below or in case of rain / wind alarm. The wind and rain protection functions are also active in manual mode if they have been set in automatic.

## OPERATION

### Key functions and display symbols of the meteorological data display

The basic position of the operating unit of the control system displays the current outdoor temperature (upper line) and the indoor temperature (lower line) as well as the function mode (automatic or manual), the battery load and the current alarm messages for rain or wind. The meteorological data are updated once per minute (and in case of a keystroke).

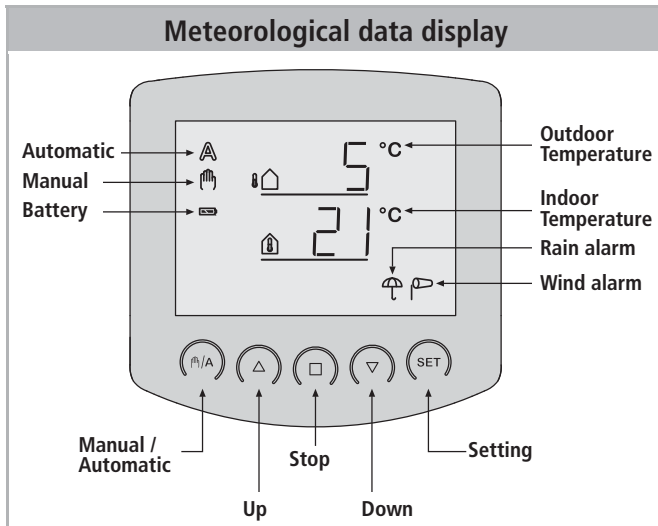

### Key assignment

	Automatic mode activated
	Manual mode activated. The connected drive mechanism was operated manually (with arrow keys) or  key was pressed. Thus, the automatic functions are deactivated, there is no control in terms of temperature. The safety functions rain alarm and wind alarm are still activated. The control is in manual mode until you change to automatic mode with  key.
	Rain alarm. The window is closed, manual operation is blocked. The rain protection function may be turned on and off in the automatic settings.
	Wind alarm. The window is closed, manual operation is blocked. The wind protection function may be set up or turned off in the automatic settings.

### Display icons

	Outdoor temperature
	Indoor temperature
<b>Battery symbol (indicates the charge status of the battery)</b>	
	Battery full
	Battery half full
	Battery empty

### Display of lightness and wind speed

Press the SET key during temperature display once for a short moment, and current lightness (in kilolux, kLux) and wind speed (in meters per second, m/sec) are displayed. The values are updated every 4 seconds.

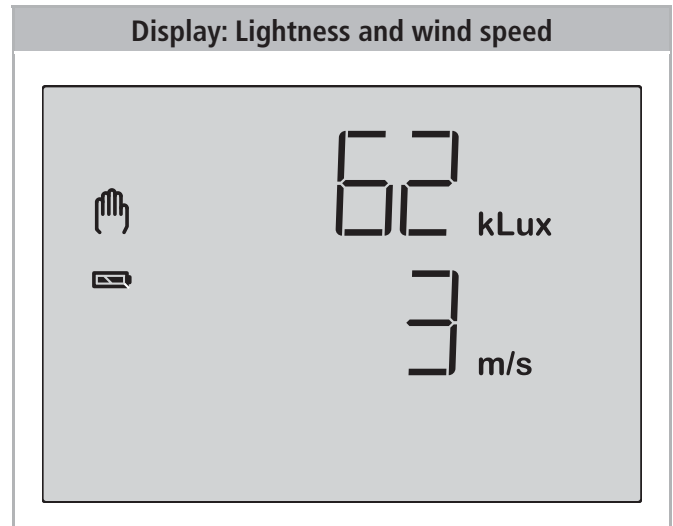

During the first approx. 90 seconds after the return of voltage at the weather station, the wind value is not displayed correctly (e.g. after a power fail or in case of a first start).

#### NOTE

Therefore, manual operation is blocked in this period of time in case of activated wind alarm.

If you press the SET key again for a short moment, you get back to the temperature display (or to the central command display, see next chapter). After approx. 60 seconds, the display switches automatically to the temperature display.

### Manual operation

Manual control as well as the presetting of the automatic functions and the basic setting of the connected shading is accomplished with the keys of the operating unit.



#### Move window manually

The connected window may be manually operated with the keys  $\Delta$ ,  $\square$  and  $\nabla$ . The arrow keys are provided with a time automatic. By short pressing (less than 1 second), the window may be exactly positioned. If the key is pressed more than 1 second, the drive mechanism moves automatically to the final position. If you press  $\square$ , the drive mechanism stops. In case of rain or wind alarm, the manual operation is blocked.

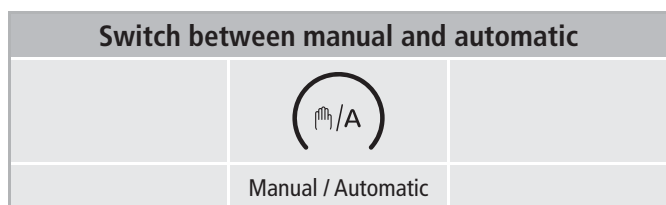

#### Switch between manual and automatic

Key  $\text{M}/\text{A}$  switches between automatic mode (display  $\text{A}$ ) and manual mode (display  $\text{M}$ ). After the manual operation with the keys  $\Delta$ ,  $\square$  or  $\nabla$ , the control system is in manual mode. The automatic functions then are deactivated, there is no control in terms of temperature.

With key  $\text{M}/\text{A}$ , the control is reset to automatic. If the next automatic command is an opening command, then the control closes the window at first (4-minute reference movement). After that the opening position is initiated.

### Central control

If the sending of meteorological data and automatic commands has been activated (see chapter 5 of the basic settings), you additionally obtain the following display after the manual mode:

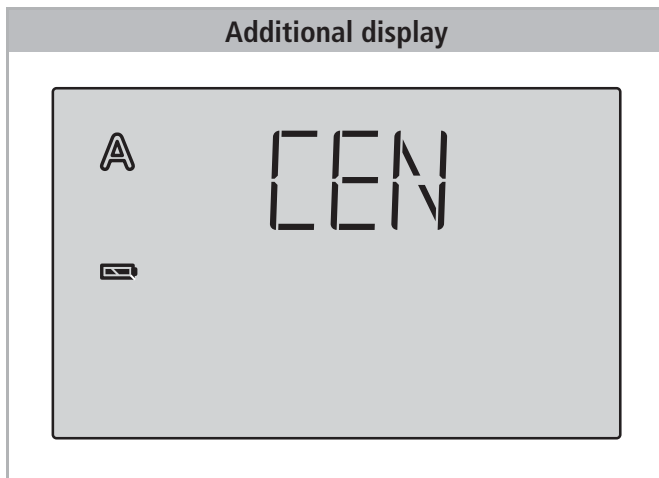

In order to get to the display, press key  $\text{M}/\text{A}$  twice shortly in automatic mode ( $\text{A}$ ) and once shortly in manual mode ( $\text{M}$ ). As long as the display shows  $\text{CEN}$ , manual operating commands of this operating unit are submitted to special Radio Engine Control units. During this display, use the keys  $\Delta$ ,  $\square$  and  $\nabla$  in order to centrally operate all drive mechanisms.

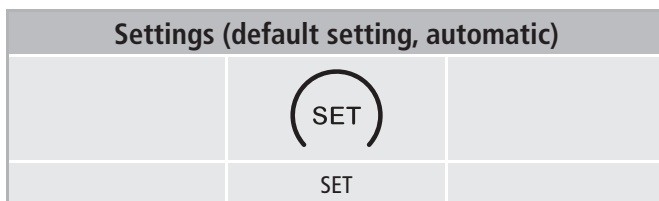

#### Settings (default setting, automatic)

With the **SET** key and by pressing shortly, you access the display of lightness and wind speed. By pressing long, you access the setting menu of the automatic and the basic setting. For this purpose, please read chapters "Setting of automatic" or „Basic settings“.



## SETTING OF AUTOMATIC

For an optimal aeration, the values for automatic operation must be adjusted to the local conditions. The following settings are queried one after the other:

- A. Indoor temperature for opening
- B. Outdoor temperature block
- C. Wind alarm
- D. Rain alarm
- E. Storage

### This is how you access the automatic settings:

 In meteorological data display, press the SET key for at least 3 seconds in order to access the automatic setting.

You are in the automatic settings as soon as the symbols  and  are shown left in the display. You can see the first parameter (lightness) which must be set.

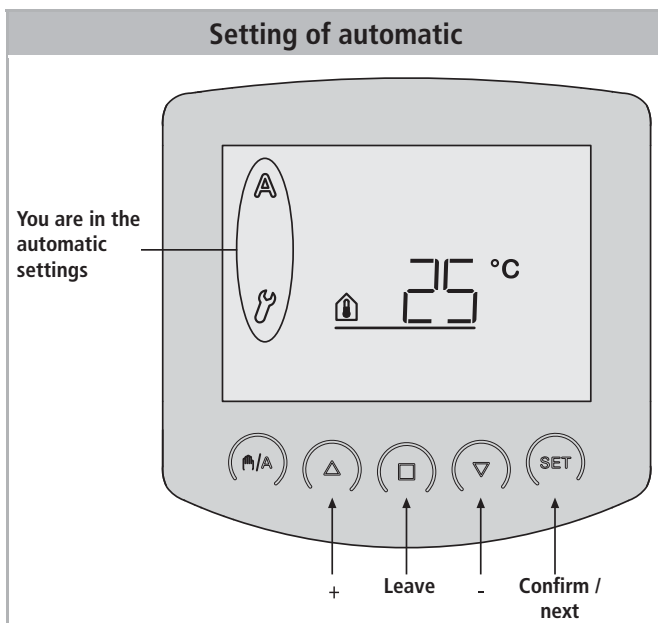

You may leave the automatic settings at any time by pressing the key . The accomplished changes of the values are not saved in this case.

If you do not press any key in the automatic settings for 5 minutes, the display automatically changes to temperature display. Accomplished settings are not saved either.





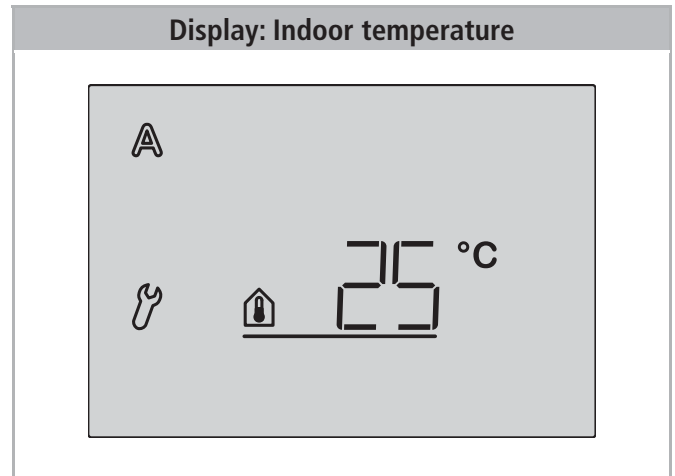

## A. Indoor temperature for opening

In the automatic settings, you must indicate at first the lightness from which shading shall start.



As soon as the value indicated here is exceeded, the automatic opens the window (unless the blocking value for the outdoor temperature has fallen below, see next parameter). The delay (hysteresis) is 2°C. That means, that the window will be closed as soon as the indoor temperature drops 2°C below the set value.

### The presetting is 25°C.

Adjust the value with  (higher) and  (lower) or select  (off) in order to switch off the function. You reach the setting  by pressing  once more when the display shows 5°C". If you select , there is no control in terms of temperature. Therefore, the following automatic parameter (chapter B) is skipped. The window may be operated manually and the protection against wind and rain is active (if set accordingly, see chapter „C. Wind alarm“ and „D. Rain alarm“).

Press SET in order to get to the setting of the next parameter.

### B. Outdoor temperature block

After the setting of the indoor temperature, now select the maximum outdoor temperature up to which the window shall remain closed.

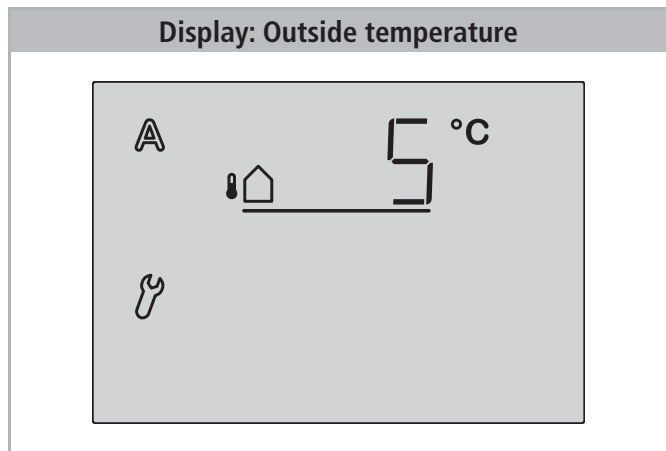

The outdoor temperature block keeps the window closed as long as the temperature is below the selected value. This means that in automatic mode, an opened window is closed and not opened again if the indoor temperature value (chapter A) is exceeded. Thus avoids energy losses during ventilation and protects plants from cold external air.



The outdoor temperature block should be set to a temperature above 0°C, if possible. If a window is opened while temperatures are below 0°C, frozen rubber seals can get damaged.

The delay (hysteresis) of the outdoor temperature block is 2°C. That means, the window ventilation is released only after the outdoor temperature has extended the set value more than 2°C.

**The presetting for the outdoor temperature block is 5°C.** Adjust the value with  $\Delta$  (higher) and  $\nabla$  (lower) or select OFF (off) in order to switch off the outdoor temperature block. You reach the setting OFF by pressing  $\nabla$  once more when the display shows "-20°C". Press SET in order to access the setting of the next parameter.

### C. Wind alarm

After the setting of the outdoor temperature block, now provide the value for the wind protection function.

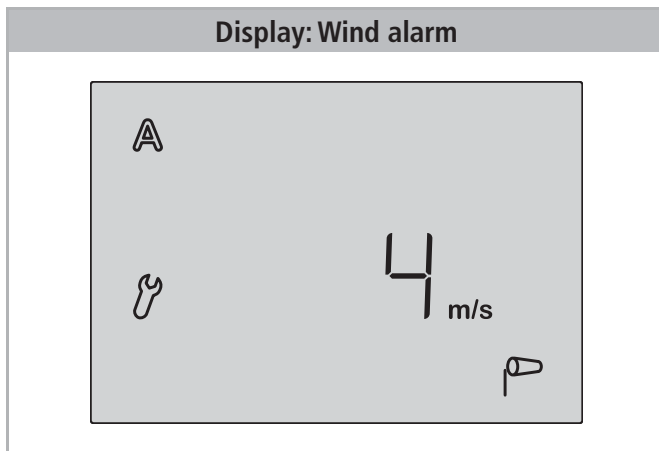

The wind alarm protects the window and furniture and fixtures from damage. If the indicated wind value is exceeded, the window closes and the manual operation is blocked. Wind speed is indicated in m/sec (meters per second).

The following table (see next chapter) serves as indication in order to set the wind value. Depending on the position of the winter garden and the assembly position of the weather station, different wind values may be optimal. Observe the behaviour of the window in case of wind and correct the wind value accordingly.

The wind alarm is maintained for 5 minutes. If the set wind value is exceeded within these 5 minutes, the stop time starts from the beginning.

**The presetting for the retraction in case of wind is 4 m/s.** Adjust the value with  $\Delta$  (higher) and  $\nabla$  (lower) or select OFF (off) in order to deactivate the function. Then press SET in order to access the setting of the next parameter.

Wind speeds				
Description	m/s	km/h	Beaufort	knots
Calm	< 0,3	< 1,1	0	< 1
Almost calm	0,3 - 1,5	1,1 - 5,4	1	1 - 3
Very weak wind	1,6 - 3,3	5,5 - 11,9	2	4 - 6
Weak wind	3,4 - 5,4	12,0 - 19,4	3	7 - 10
Moderate wind	5,5 - 7,9	19,5 - 28,4	4	11 - 16
Fresh wind	8,0 - 10,7	28,5 - 38,5	5	17 - 21
Very fresh wind	10,8 - 13,8	38,6 - 49,7	6	22 - 27
Strong wind	13,9 - 17,1	49,8 - 61,5	7	28 - 33
Very strong wind	17,2 - 20,7	61,6 - 74,5	8	34 - 40
Storm	20,8 - 24,4	74,6 - 87,8	9	41 - 47
Heavy storm	24,5 - 28,4	87,9 - 102,2	10	48 - 55
Gale-force wind	28,5 - 32,6	102,3 - 117,3	11	56 - 63
Hurricane	> 32,6	> 117,3	12	> 63



### D. Rain alarm

After the setting of the wind alarm, now select whether the rain alarm shall be switched on or off.

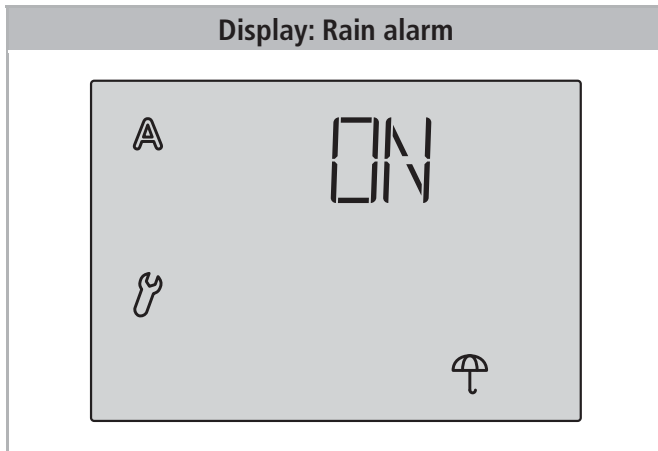

The rain alarm protects furniture and fixtures from damage. In case of rain, the window is automatically retracted and the manual operation is blocked. The rain message is maintained for 5 minutes. If the system recognises rain again during these 5 minutes, the stop time starts from the beginning. In the presetting, the rain alarm is activated (display ON). With the arrow keys, you may select between activated (display ON) and deactivated (display OFF). Then press SET in order to get to the storage of the setting.

### E. Storage of automatic settings

At the end of the entry of automatic settings, the symbol SAN (save) asks whether the accomplished setting shall be saved.

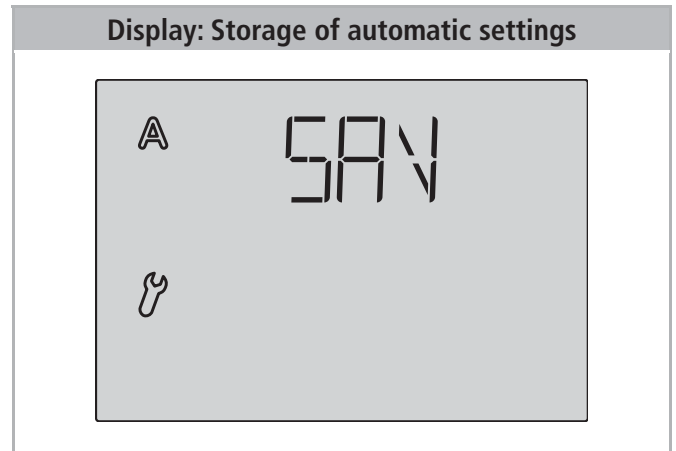

Press the SET key in order to save your entered data and to access the meteorological data display. With □, you quit the automatic settings without saving.

## BASIC SETTINGS

These are the basic settings of the device for the commissioning of the control system. The following settings are queried one after the other:

1. Radio connection to the weather station
2. Rotational direction of the motor
3. Operating direction
4. Operating command in case of wind or rain alarm
5. Sending of meteorological and automatic data
6. Opening position
7. Save

#### This is how you access the basic settings:

**SET** In meteorological data display, press the SET key for at least 3 seconds in order to access the automatic setting.

You are in the automatic settings as soon as the symbols A and ⚙ are indicated left in the display.

**SET** Then press again SET for at least 3 seconds in order to access the basic settings.

You are in the basic settings as soon as the symbol ⚙ is indicated left in the display and as soon as you can see the first setting step (radio connection).

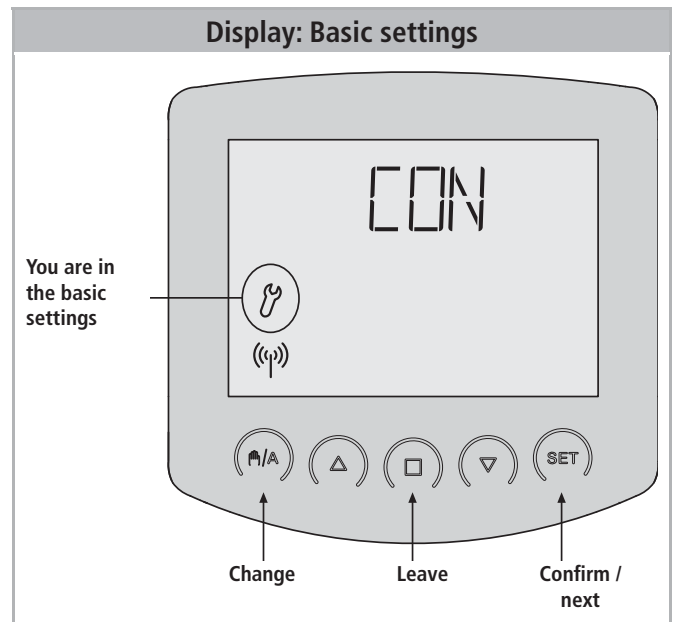

You may leave the basic settings at any time by pressing the key □. The accomplished changes are not saved in this case.

If you do not press any key in the basic settings for 5 minutes, the display automatically changes to temperature display. Accomplished settings are not saved either.

### 1. Radio connection to the weather station

The first step is the teaching in (or later the deletion) of the radio connection.

**Display: Radio connection to the weather station**



Select the desired step with the  $\text{F}/\text{A}$  key:  
**CON** (continue) in order to skip this step,  
**LEA** (learn) in order to teach in a radio connection to the weather station,  
**CLR** (clear) in order to delete an existing radio connection.

Confirm your selection with the **SET** key.

As soon as you have confirmed **LEA** (learn) with the **SET** key, the radio symbol stops flashing and the radio waves are animated (they "run"). Now there are two possibilities.

#### 1. Interrupt voltage supply:

(From version 4.0 of weather station. Query of software version see "Query service data") Briefly interrupt the voltage supply of the weather station by switching off and on the fuse. The radio connection is learned immediately after switching on again.

#### 2. Programming key of the weather station:



This option of the teaching in may only be accomplished by a qualified person for electronics.

Press the programming key inside the weather station in order to teach in the radio connection (you can find a diagram of the circuit board in the chapter „Preparation of the weather station“).

The learning has been successful if the LED next to the programming key shortly flashes twice and the display skips to step 2 of the basic settings (rotational direction of the motor).

As soon as you have confirmed **CLR** (clear) with the **SET** key, the radio connection is deleted. The display automatically skips to **LEA** (learn) in order to enable the teaching in of a new connection.

#### Delete all radio connections of the weather station

You can delete all radio connections of the weather station with operating units and hand-held transmitters at once by pressing the programming key for longer than 5 seconds. The programming LED will go on for 1 second for affirmation. Connections to motor control units are not deleted during this procedure.

### 2. Rotational direction of the motor

After the teaching in of the radio, you may now set the rotational direction of the motor.

**Display: Rotational direction of the motor**

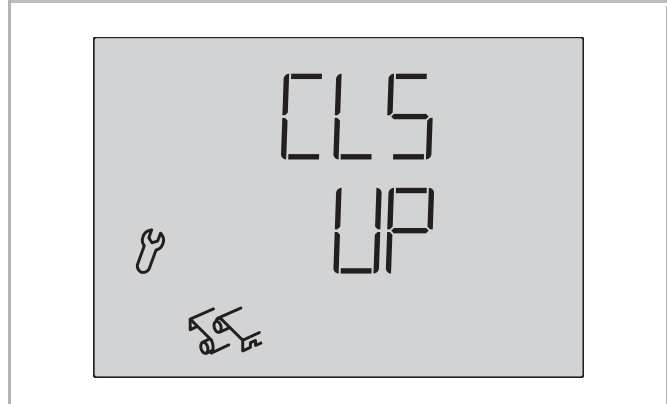

If the up and down connection cables have been mixed up when connecting the drive mechanism, this may be corrected in this step. First open the window a little bit for the rotational direction test. Check both arrow keys and make a setting in the display, whether the window closes again with  $\Delta$  or with  $\nabla$ .

If the window closes (**CLS**, close) with key  $\Delta$ , then select the display **UP** (up) with the key  $\text{F}/\text{A}$ .

If the window closes (**CLS**, close) with key  $\nabla$ , then select the display **DN** (down) with the key  $\text{F}/\text{A}$ .

Press the **SET** key in order to access the next setting step.



Rain and wind alarm are deactivated for this test.

### 3. Operating direction

After the setting of the rotational direction of the motor, now select which key shall open the window.

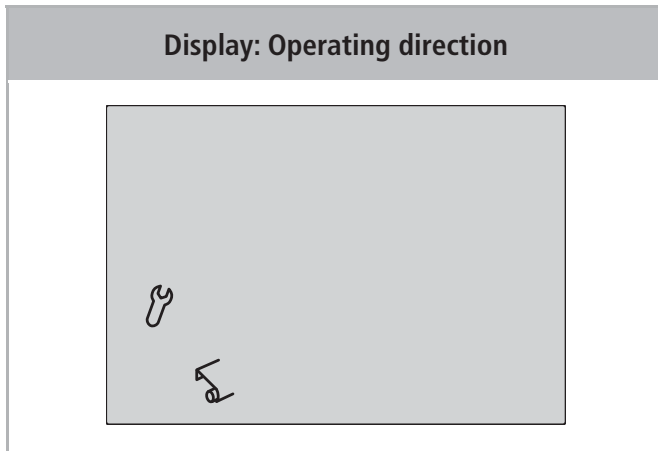

In this step, you change the allocation of the arrow keys so that they correspond with the operating direction of the window. You may directly test the setting with the arrow keys.

Press the key  $\text{F}_1/\text{A}$  in order to switch between the displayed symbols.

Select

 if the window shall open with the key  $\Delta$  or

 if the window shall open with the key  $\nabla$ .

Press the **SET** key in order to access the next setting step.



Rain and wind alarm are deactivated for this test.

### 4. Operating command in case of wind or rain alarm

After the setting of the operating direction, you may now select whether the operating command in case of wind or rain alarm is temporary or permanent.

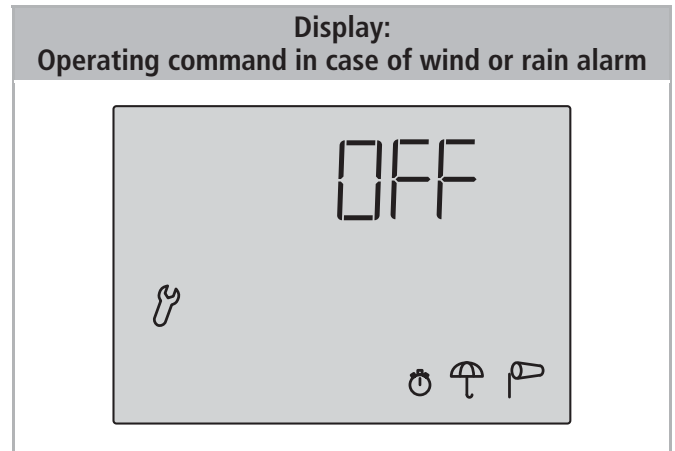

After the wind or rain alarm has been activated, the window is closed. The operating command for the connected drive mechanism either ends after 4 minutes or is permanently maintained as long as the alarm message exists.

The permanent operating command is necessary if **FLS 24V** is used as Control Unit for wired connection devices (e. g. SHEV - Control Unit, control devices, module, etc.).

Press the key  $\text{F}_1/\text{A}$  in order to switch between the displays **OFF** and **ON**.

Select

**OFF** if in case of alarm, the operating command shall stop after 4 minutes (setting for conventional window control systems) or

**ON** if in case of alarm, the operating command shall be permanently activated (operating command ends as soon there is no alarm message anymore).

Press the **SET** key in order to access the next setting step.

### 5. Sending of meteorological and automatic data

After the setting of the operating command in case of wind or rain alarm, you may now select, whether the meteorological data and the automatic commands of **FLS 24V** be submitted by radio to special radio engine control devices. (Note: This feature is not supported.)

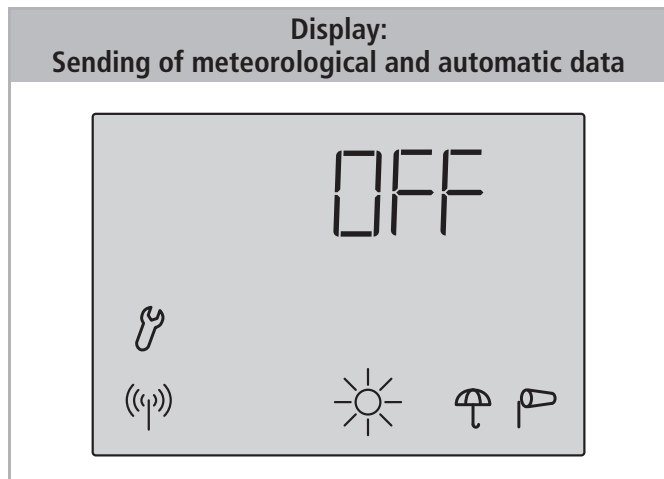

Please leave this display at **OFF** and use the **FLS 24V** as single-channel control.

Press the **SET** key in order to access the next setting step.

### 6. Opening position

After the setting of the sending of meteorological and automatic data, you may now teach in an opening position.

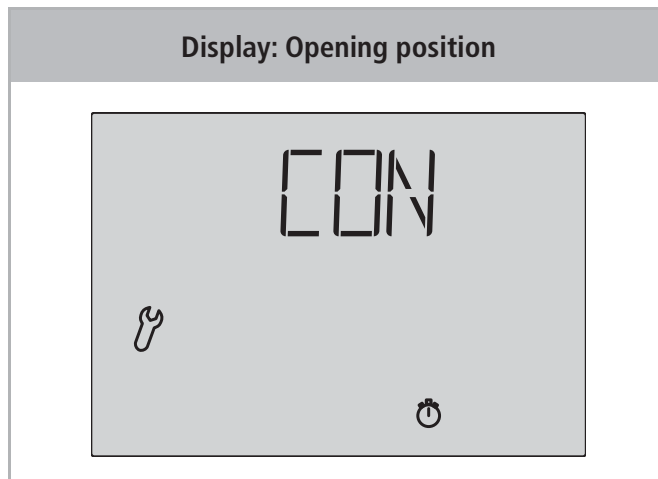

You may determine an individual position for the window up to which it opens in automatic mode.

Select the desired step with the **⏏/A** key:

**CON** (continue) in order to skip the setting of the opening position. The window is then always completely opened by the automatic. In this case, continue as described in chapter „7. Saving basic settings“.

**LEA** (learn) in order to teach in the opening position.

**CLR** (clear) in order to delete an already taught in opening position. The window is then again always completely opened by the automatic. In this case, continue as described in chapter „7. Saving basic settings“.

Confirm your selection with the **SET** key.

**NOTE**

If the control is switched from manual to automatic mode and the next automatic command is an opening command, then the control closes the window at first (4-minute reference movement). After that the opening position is initiated.

**6.1. Closed position**

After having confirmed **LEA** (learn), the command **CLS** (close) appears.

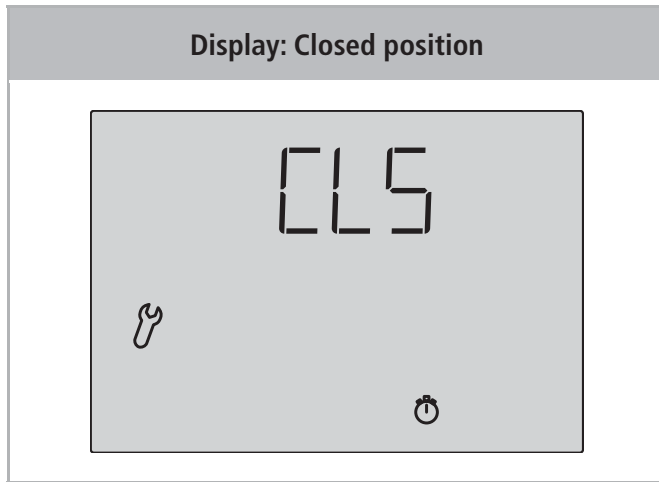

At first, completely close the window. Then press the **SET** key in order to access the next setting step.

**6.2. Setting of the desired position**

The command **OPN** (open) appears.

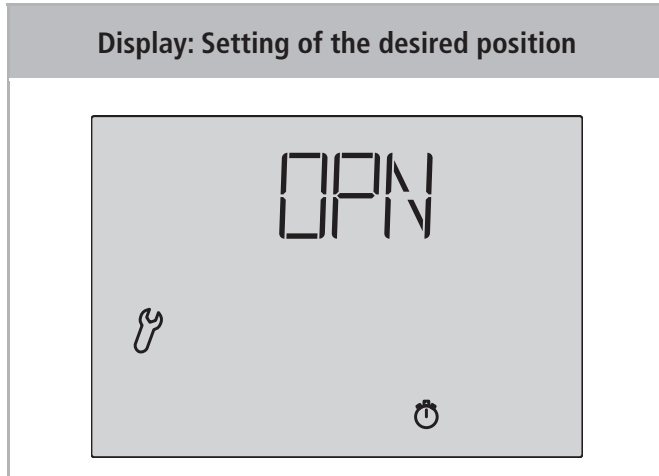

Now open the window as far as the automatic shall do it later. Then press the **SET** key in order to access the next setting step.

**7. Saving of basic settings**

At the end of basic settings, the symbol **SAV** (save) asks whether the accomplished setting shall be saved.

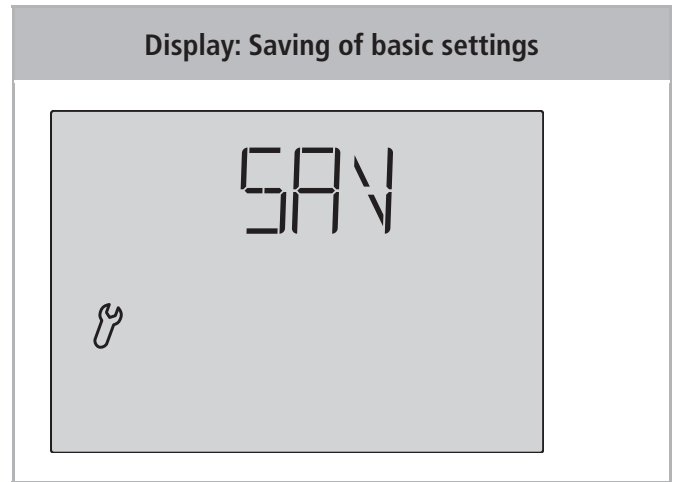

Press the **SET** key in order to save your entered data and to access the meteorological data display. With , you quit the basic settings without saving.

After the basic setting, the values for the automatic functions may be set. In case of first commissioning, please check the function of the sensors in advance (see chapter "Sensor testing").

**SAFETY INSTRUCTIONS  
FOR AUTOMATIC AND ALARM FUNCTIONS**

In case of power fail at the weather station, the control system cannot actuate the connected drive mechanisms anymore! If the complete scope of functions must be guaranteed in case of power fail, an emergency power generator with an according switch-over from mains operation to emergency operation must be installed. Saved settings in the programme of the control also retain in case of power fail.  
After the return of voltage, the control is in automatic mode.

If the radio connection between operating unit and weather station is interrupted (e.g. by radio interference or empty batteries in the operation unit), it is not possible anymore to take manual action. The control remains in the current mode (manual or automatic). The automatic mode continues as preset until there is radio connection again, however without considering the indoor temperature. In case of a preset manual mode, the wind and rain protection functions are retained as well.

If cleaning and maintenance works in the environment of the awing(s) or blind(s) must be accomplished, the control system (weather station) must be switched to neutral by switching off the installed fuse and be prevented from unintentional restart. Thus you ensure that the connected drive mechanisms do not start operation.

In case of beginning rain, a certain period of time, which depends on the amount of rain, may pass by until the weather station recognises that there is rain.  
In addition, a closing time must be taken into account for electrically operated windows or sliding roofs. Any items that are sensitive to moisture should therefore not be placed in areas where they might be damaged by penetrating moisture.  
Please also consider that for example in case of power failure and incipient rain the windows are no longer automatically closed if no emergency power generator has been fitted.



Please make absolutely sure that there aren't any persons within the operating range of unit components which are operated by an electric motor (danger of crushing!).  
The according building regulations must be observed.

**SAFETY INSTRUCTIONS  
INSTALLATION AND COMMISSIONING**



Attention, mains voltage!  
The legal national regulations must be complied with.

Installation, inspection, commissioning and troubleshooting of the control system must only be carried out by a competent electrician. Disconnect all lines to be assembled, and take safety precautions against accidental switch-on.

The control system is exclusively intended for appropriate use. With each inappropriate change or non-observance of the instructions for use, any warranty or guarantee claim will be void.

After unpacking the control, check immediately for any mechanical damages. In case of transport damage, this must immediately notified to the supplier.



If damaged, the control system must not be put into operation.

If it must be assumed that safe operation of the control or of the connected drives is no longer guaranteed, the conservatory control must be put out of operation and be secured against accidental operation.

The control must only be operated as stationary system, i.e. only in a fitted state and after completion of all installation and start-up works, and only in the environment intended for this purpose.

**AUMÜLLER AUMATIC GmbH** does not assume any liability for changes in standards after publication of this instruction manual.

## INSTALLATION OF WEATHER STATION AND CONNECTION OF THE CONNECTION DEVICES

### Position

Select an assembly site at the building where wind, rain and sun may be collected by the sensors unobstructedly. Do not assemble any construction components above the weather station from where water may drop on to the rain sensor after it has stopped raining or snowing.

The weather station may not be shaded by the building or for example by trees. At least 60 cm of clearance must be left all round the weather station. This facilitates correct wind speed measurement without eddies. The distance concurrently prevents spray (raindrops hitting the device) or snow (snow penetration) from impairing the measurement.

It also does not allow birds to bite it. Please ensure that an extended awning does not cast shade on the unit, and that this is not protected from the wind.

Temperature measurements can also be affected by external influences such as by warming or cooling of the building structure on which the sensor is mounted, (sunlight, heating or cold water pipes).

### Installation of the weather station

There must be **at least 60 cm of space** below, to the sides and in front of the weather station left **from other elements** (structures, construction parts, etc.).

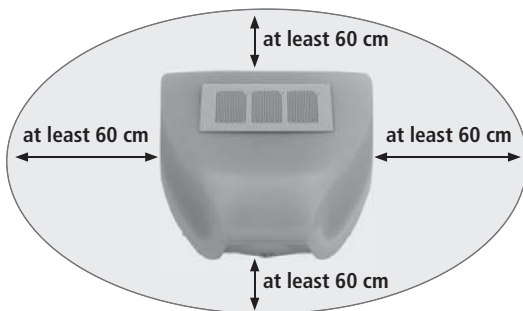

The weather station **must be mounted on a vertical wall** (or a pole).

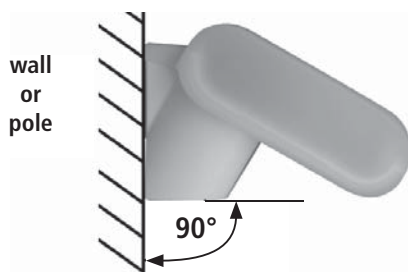

The weather station must be mounted in the **horizontal transverse direction** (horizontally).

Mount horizontally



### Attaching the mount

The weather station includes a combined wand / pole mount. On delivery, the mount is attached to the rear side of the housing with an adhesive strip.

#### Attaching the mount

Fasten the mount vertically onto the wall or pole.

When **wall mounting**: flat side on wall, crescent-shaped collar upward.

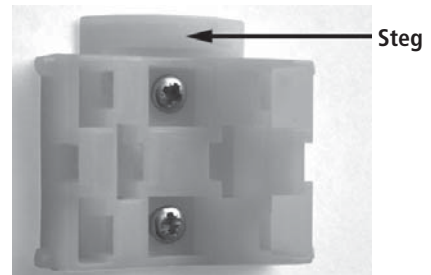

When **pole mounting**: curved side on pole, collar downward.

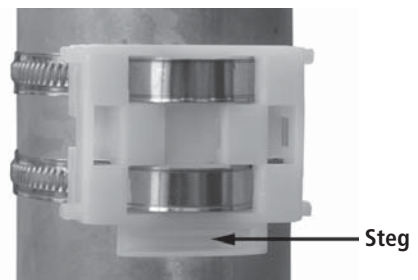

An additional, optional accessory available from Elsner Elektronik is an articulated arm for flexible wall, pole or beam mounting of the weather station.

#### Example of the use of a mounting arm:

Due to flexible ball joints, the sensor can be brought into ideal position.



#### Example of the use of a mounting arm:

Due to the hinge arm mounting, the sensor protrudes under the roof projection.



#### Example of the use of a mounting arm:

Pole-mounting with mounting brackets.



### Preparation of the weather station

The cover of the weather station with rain sensor is engaged at the lower rim to the right and to the left (see fig.) Remove the cover from the weather station. Be careful not to break away the cable connection between the circuit board in the bottom part and the rain sensor in the cover.

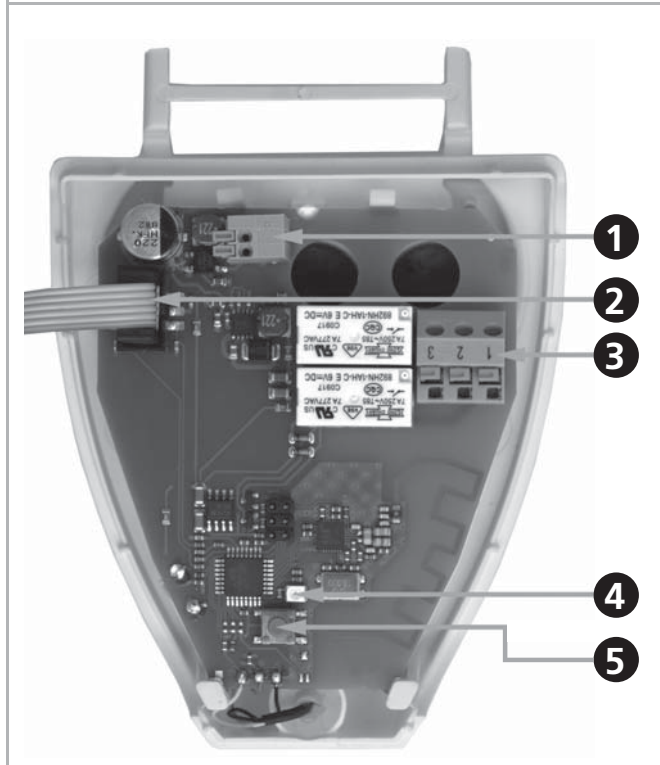
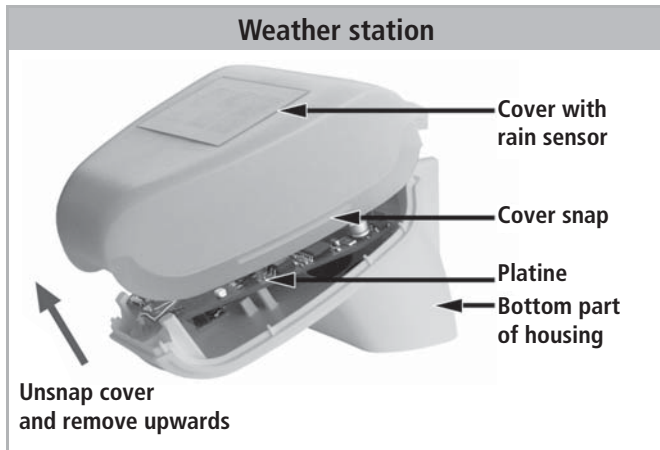

- 1 Connections for voltage supply**  
(13...30 V DC / 12...24 V AC, tension clamp, +/-GND), suitable for massive conductors of up to 1,5 mm<sup>2</sup> or conductors with fine wires
- 2 Cable connection**  
to the rain sensor in the housing cover
- 3 Connections for SHEV - Control Unit, control devices, module, etc.**  
(tension clamp, 1 = COM / 2 = OPEN / 3 = CLOSE), suitable for massive conductors of up to 1,5 mm<sup>2</sup> or conductors with fine wires
- 4 Programming LED.**  
In normal operation, this LED indicates the receipt of a valid data package by a short flashing
- 5 Programming key**  
for teaching in the radio connection to the operating unit

### Connection of voltage supply and control devices (e.g. SHEV - Control Unit, control devices, module, etc.)

The connection devices are connected to the weather station. Several connection devices may be connected in parallel. In case of the parallel connection of motors, please observe whether a group control relay is specified by the motor manufacturer.

Group control relays may be provided by **AUMÜLLER AUMATIC GmbH**.



If motors are connected in parallel which are not suited for this purpose, both motor and control system are damaged.

Motors with a rated input of more than 1000 Watt must be operated with a relay or contactor with own feeder.

#### Installation of the weather station

The control panel is battery operated. Communication between the keypad and weather station is via radio.

Terminal X1: Operating voltage  
Terminal X2: Output

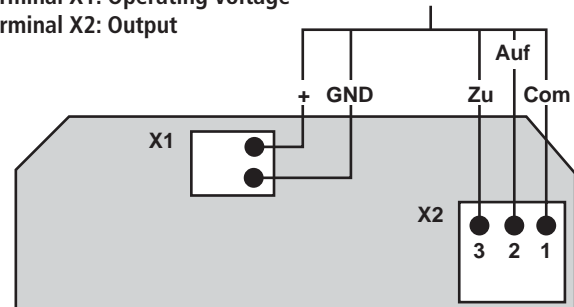

#### Connection plan:

##### FLS 24V at SHEV - Control Unit EMB 7300

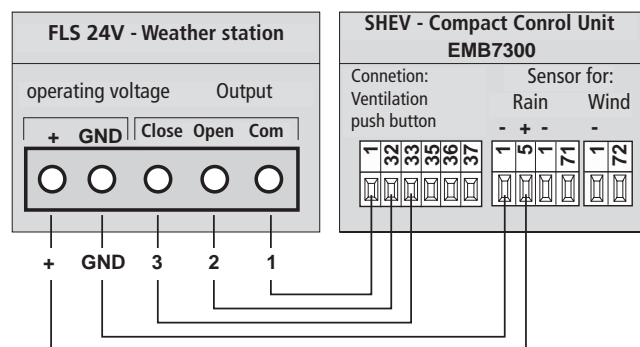

##### FLS 24V at Ventilation-Module LZA

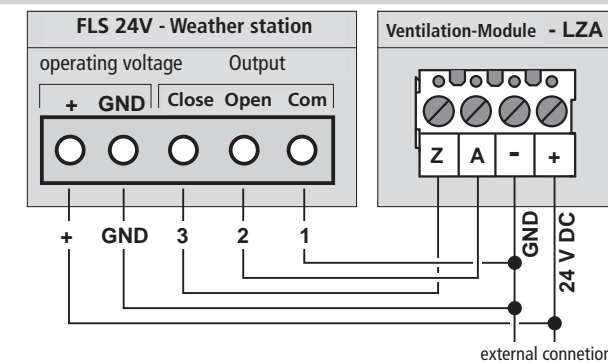



## Installation

- 1.) Pass the cable for voltage supply and connection devices through the rubber sealing at the bottom side of the weather station. Connect the voltage (+ / GND) and connection devices (1 = COM / 2 = OPEN / 3 = CLOSE) to the provided terminals.

The programme button for the wireless connection is on the weather station board. To teach the wireless connection to the control unit, please see Chapter „Commissioning“ and „1st Wireless Connection to the Weather Station“ in the basic settings.

### NOTE

- 2.) Close the housing by putting the cover over the bottom part. The cover must engage at the right and at the left with a clearly noticeable “click”.
- 3.) Check whether cover and bottom are correctly engaged! The figure illustrates the closed weather station from below

### Weather station - fastening

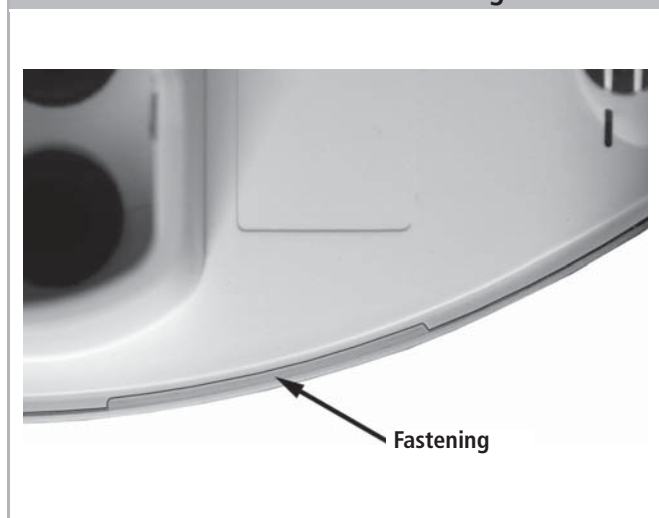

## Mounting of the weather station

Push the housing into the mounted holder from above. The journals of the holder must engage with the rails of the housing.

### Mounting: Weather station



If you want to remove the weather station, you must pull it out of the holder in upwards direction against the resistance of the engagement.



Do not open the weather station if water (rain) might ingress: Even some drops might damage the electronic system.

Observe the correct installation. Wrong installation might destroy the weather station and the control electronics.



Please take care not to damage the temperature sensor (small circuit board at the bottom part of the housing.) when mounting the weather station. Please also take care not to break away or bend the cable connection between the circuit board and the rain sensor when connecting the weather station.

### INSTALLATION OF OPERATING UNIT

The operating unit is battery-powered and communicates with the weather station per radio.

When you select the assembly site, please avoid direct sun because this would distort the measurements of the indoor temperature. The appropriate sensor is integrated in the lower part of the operating unit. For the same reason, the operating unit should not be installed above the heater. Please make also sure that there is no direct air supply coming from windows or doors which would distort measured values.



The operating unit may be installed and operated in dry interior rooms only. Relative air humidity may not exceed 80%.  
Avoid condensation.

### INSTALLATION OF THE RADIO SYSTEM

**NOTE**

When planning facilities with devices that communicate via radio, adequate radio reception must be guaranteed. The range of wireless control will be limited by legal regulation and structural circumstances.

Avoid sources of interference and obstacles between receiver and transmitter, that could disturb the wireless communication. Those would be for example:

- Walls and ceilings (especially concrete).
- Metal surfaces next to the wireless participants (e. g. aluminium construction of a conservatory).
- Other wireless devices and powerful local transmitters (e.g. wireless headphones), which transmit on the same frequency (868,2 MHz). Please maintain a minimum distance of 30 cm between wireless transmitters for that reason.

### Commissioning of the radio system



If a device is brought from a cold to a warm area, condensation can form. Before starting the device up, please ensure there is no moisture inside it (if necessary leave to dry).

**After the system has been wired and the connections have been checked, please proceed as follows:**

- 1.) Switch on the power supply voltage of the weather station.
- 2.) Insert batteries in the operating unit as described in chapter "Insert batteries".
- 3.) The display of the operating unit now indicates that the radio connection between weather station and operating unit is not taught in.

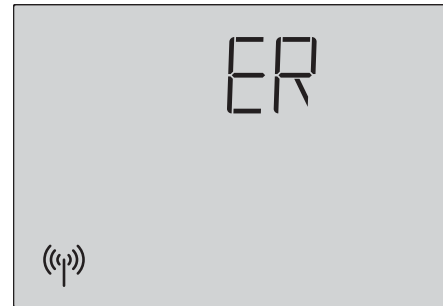

- 4.) Press SET key for 3 seconds until the following display appears:

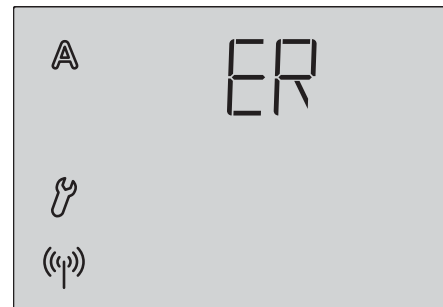

- 5.) Press SET again for 3 seconds until the display for the teaching in of the radio connection appears. Now you are in basic settings. Proceed as described in the basic settings chapter „1. Radio connection to weather station“.

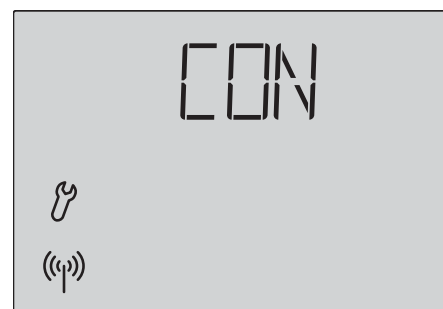

- 6.) Then check the function of the sensors (see next chapter).

## SENSOR TESTING

### Malfunctions

In case of malfunctions of the sensors, the display shows error messages instead of values. Please observe the chapter „Error messages“ on this.

### Sun sensor testing

By the short pressing of the SET key on the operating unit you get to the lightness display (see chapter „Display of lightness and wind speed“). The upper value indicates the intensity of lightness in kilolux (kLux).

The sun sensor is located beneath the frosted glass cover of the weather station. If lightness is not sufficient, you must illuminate the weather station from above with a powerful torch until a value is indicated.

### Wind sensor testing

By the short pressing of the SET key on the operating unit you access the wind speed display (see chapter „Display of lightness and wind speed“). The lower value indicates the speed in meters per second (m/sec). The sensor pipe is on the front side at the bottom part of the weather station. If you blow in there, the value in the display changes.

**NOTE**

During the first approx. 90 seconds after the return of voltage at the weather station, the wind value is not displayed correctly (e.g. after a power fail or in case of a first start).

### Rain sensor testing

Humidify one or several of the golden sensor areas in the cover of the weather station. The ☂ symbol (rain alarm) appears in the display. For this purpose, the rain alarm in the automatic settings must be activated (this is the presetting as delivered, also see chapter „G. Rain alarm“).

Please observe that the rain message is maintained for 5 minutes after the drying of the sensor.

### Temperature sensor testing

If reasonable values are displayed next to the symbols ⬆ (outdoor temperature) and ⬆ (indoor temperature), a correct function may be assumed.

## SERVICE

### Service and maintenance

#### Weather station

The weather station must regularly be checked for dirt twice a year and cleaned if necessary. In case of severe dirt, the wind sensor may not work properly anymore, there might be a permanent rain message or the station may not identify the sun anymore.

In case of power fail, the entered data will be stored for approx. 10 years. Batteries are not necessary for this purpose.



For safety reasons, the weather station should be disconnected from the mains current (e.g. deactivate / remove fuse) if you want to accomplish maintenance and cleaning works.

#### Operating unit

Clean the display with a wet cloth, if necessary.

#### Insert batteries (operating unit)

The battery compartment is inside the housing.

##### Insert batteries

Open the operating unit by unlocking the locking at the lower rim of the housing. For this purpose, you must press with a screwdriver straight into the gap.



Observe the correct polarity of the batteries.



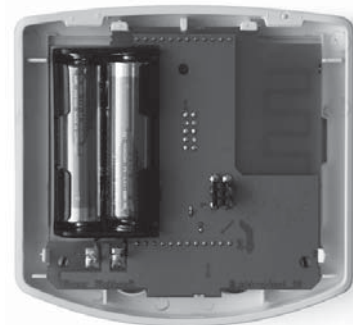



You need two standard batteries (1.5 V) or accumulators (1.2 V) of type AA (Mignon/ LR6).

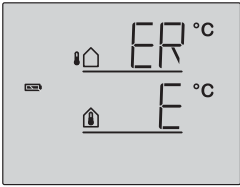

Close the housing by fitting the front panel with circuit board from above into the rear panel. The locking must engage with a clearly noticeable „click“.

**Error messages**

Despite the values for temperature, lightness or wind speed, the display may indicate error messages in the meteorological data display.

Error messages	
<b>Error:</b>	Battery is displayed, no other symbols or values. Manual operation is possible.
<b>Cause:</b>	Batteries in the operating unit are empty and must be changed. Attention: The function of the operating unit may not be guaranteed anymore.
<b>Action:</b>	Change batteries as described in chapter "Insert batteries".
	
<b>Error:</b>	ER and the symbol for radio appear in the display.
<b>Cause:</b>	No radio connection between operating unit and weather station. The weather station is out of order (e.g. has no voltage) or the radio connection is interrupted or has not yet been taught in.
<b>Action:</b>	The teaching in of the radio connection between weather station and operating unit is described in chapter „1. Radio connection to weather station“.
  <p>The error may only be corrected by a qualified person for electronics. Therefore, please contact your fitter.</p>	
<b>Error:</b>	ER instead of outdoor temperature or E instead of indoor temperature.
<b>Cause:</b>	The outdoor temperature sensor of the weather station or the indoor temperature in the operating unit is defect.
  <p>The error may only be corrected by a qualified person for electronics. Therefore, please contact your fitter.</p>	
<b>Error:</b>	ER instead of lightness or E instead of wind speed.
<b>Cause:</b>	Lightness sensor or wind sensor of the weather station are defect.
  <p>The error may only be corrected by a qualified person for electronics. Therefore, please contact your fitter.</p>	

**Query service data**

The software version of the operating unit and the weather station may be indicated in the display. From the basic settings you may get to the service menu by a long pressing of SET (3 seconds). At first, the software version of the operating unit ( PPN , panel) is indicated, after the short pressing of SET , the software version of the control/weather station ( PR , Arexa) is indicated. Display 10 means version 1.0, 12 means 1.2, etc. Quit the service data display by another short pressing of SET .

**Factory settings**

The following presetting for the automatic is stored when the Radio Ventilation Control FLS 24V is delivered:

- Opening from indoor temperature > 25°C
- Blocking until outdoor temperature > 5°C
- Wind alarm beginning with 4 m/s
- Rain alarm activated

Personal settings data of the automatic	
Open from inside temperature higher	<input type="text"/> °C
Outdoor temperature lock below	<input type="text"/> °C
Wind alarm from	<input type="text"/> m / s
Rain alarm	Yes <input type="checkbox"/> or No <input type="checkbox"/>

**TECHNICAL DATA**

The product conforms with the provisions of EU directives.

Operating unit	
Housing	Plastic material (partly lacquered)
Colour	White matt (similar to RAL 9016)
Mounting	On-wall
Protection rating	IP 40
Dimensions (W × H × D)	approx. 103 mm × 98 mm × 28 mm
Total weight	approx. 170 g (including batteries)
Ambient temperature range	Operation 0...+50°C Storage -10...+50°C
Ambient air humidity	max. 80% rF, avoid bedewing
Operating voltage	2 x 1,5 V (2 batteries, AA / Mignon / LR6) or 2 x 1,2 V (2 rechargeable batteries, AA / Mignon / LR6)
Radio frequency	868,2 MHz

Weather station	
Housing	Plastic material
Colour	White / translucent
Mounting	On-wall
Protection rating	IP 44
Dimensions (W × H × D)	approx. 96 mm × 77 mm × 118 mm
Weight	approx. 200 g
Ambient temperature range	Operation -30...+60°C Storage -30...+70°C
Operating voltage	13...30 V DC, 12...24 V AC
Power consumption	Stand by: approx. 2 W / 24 V Operation: approx. 2,2 W / 24 V
Output	CLOSE / OPEN / COM, can carry up to 1000 W / 230 V, volt free contact
Heating rain sensor	approx. 1,2 W
Measurement range temperature	-40...+80°C Resolution: 0,6°C
Measurement range wind	0...35 m/s Resolution: 1 m/s
Measurement range brightness	0...150 kLux Resolution: 1 kLux

**Operating unit: View of the back**

All values are in mm, deviations due to technical reasons are possible.

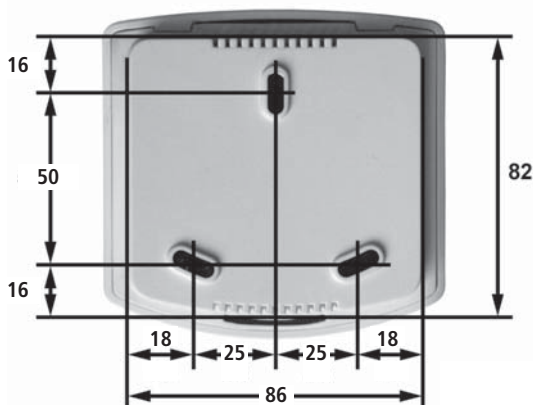

**Operating unit: hole layout**

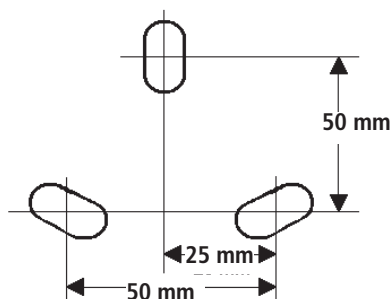

3x Long hole 13 x 5 mm

**Weather station: View of the back**

All values are in mm, deviations due to technical reasons are possible.

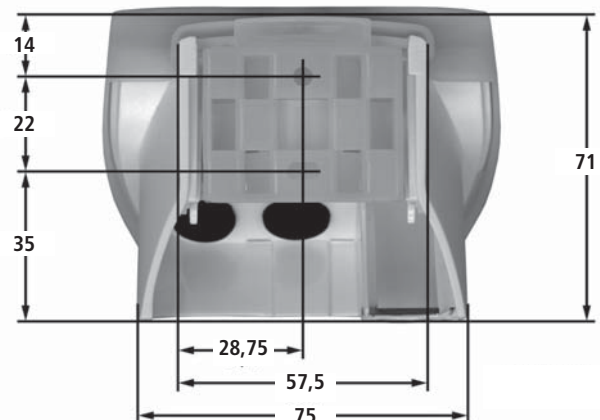

**Weather station: hole layout**

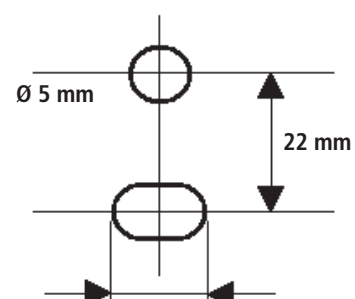

Long hole 7,5 x 5 mm

## DEMOUNTING AND DISMANTLING

The Control Unit shall be stored only in locations protected from moisture, severe contamination and temperature fluctuations (not beyond 30°C). The packaging shall not be removed until the control system is to be installed. Disconnect the batteries and store them separately after the control device has already been in operation.

**It is imperative that the following is observed for the storage of the batteries:**



Keep the storage time of lead-acid batteries short, because the batteries discharge as time passes. At the latest after seven months in storage batteries must be recharged. Use either a suitable battery charger or connect the batteries to an EMB Control Unit and supply same with mains voltage. In both cases the charging time requires a minimum of 8 hours (depending on the discharge).

In case the Control Unit is permanently decommissioned the statutory provisions for the destruction, recycling and disposal shall be observed. The control device contains plastic, metal, electrical components and batteries. Replaced batteries contain highly toxic pollutants and may therefore only be disposed of at collection points prescribed by the legislator.



Before dismantling the Control Unit separate same completely from the mains!

## DISPOSAL

According to the European Directive 2012/19 / EU on Waste Electrical and Electronic Equipment (WEEE) and its transposition into national law, obsolete electrical appliances must be collected separately and sent for environmentally friendly recycling.

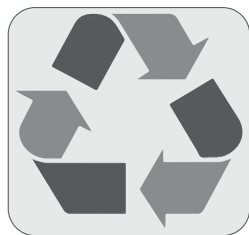

## WARRANTY AND CUSTOMER SERVICE

In principal apply our:

„General Terms for the Supply of Products and Services of the Electrical Industry (ZVEI)“.

„Terms for the used software“.

The warranty corresponds with legal provisions and applies to the country in which the product has been acquired.

The warranty includes material and manufacturing defects incurred during normal use.

The warranty period for delivered material is twelve months.

Warranty and liability claims for personal injuries or material damages are excluded, if caused by one or more of the following:

- Improper use of the product.
- Improper installation, commissioning, operation, maintenance or repair of the product.
- Operating the product by defect and improper installed or not functioning safety and protection devices.
- Ignoring instructions and installation requirements in these instructions.
- Unauthorized constructional modifications at the product or accessories.
- Disaster situations due to effects of foreign bodies and Acts of God.
- Wear and tear.

Point of contact for possible warranty claims or for repair parts or accessories is the responsible branch office or the responsible person at

**Firm AUMÜLLER Aumatic GmbH.**

Contact data are available at our homepage

([www.aumueller-gmbh.de](http://www.aumueller-gmbh.de))

## LIABILITY

We reserve the right to change or discontinue products at any time without prior notice. Illustrations are subject to change. Although we take every care to ensure accuracy, we cannot accept liability for the content of this document.

**TRANSLATION OF THE ORIGINAL INSTRUCTIONS (GERMAN)****Important note:**

We are aware of our responsibility, which is why we present life-supporting and value-preserving products with greatest possible conscientiousness. Although we make every effort to ensure that the data and information are as correct and up-to-date as possible, we still cannot guarantee that they are free from mistakes and errors.

All information and data contained in this document are subject to alterations without prior notice. Distribution and reproduction of this document as well as the use and disclosure of its content is not authorized unless expressly approved. Offenders will be held liable for the payment of damages. All rights reserved in the case of a patent award or utility model registration.

Basically the General Terms and Conditions of Aumüller Automatic GmbH apply to all offers, supplies and services.

The publication of these assembly and commissioning instructions supersedes all previous editions.

AUMÜLLER AUMATIC GMBH  
Gemeindewald 11  
86672 Thierhaupten

Tel. +49 8271 8185-0  
Fax +49 8271 8185-250  
info@aumueller-gmbh.de

[www.aumueller-gmbh.de](http://www.aumueller-gmbh.de)

9000028601\_V0.1\_KW30/18